



Montagearten; Bauhöhe 7.4 mm

Für Lötstift 90°, 9.4 mm (YC)

Assemblies; mounting height 7.4 mm

For solder pin 90°, 9.4 mm (YC)

M46 x

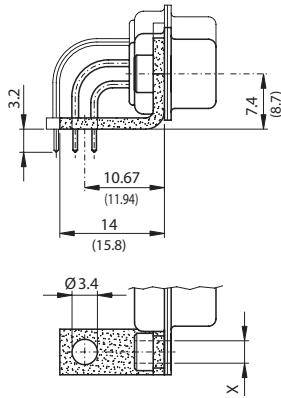

Metallwinkel / Metal bracket

| | | |
|--------|------------------|----------|
| M46 D3 | Niete / rivet | Ø 3.1 mm |
| M46 UN | Niete / back nut | UNC4-40 |
| M46 M3 | Niete / back nut | M3 |

M46 x x

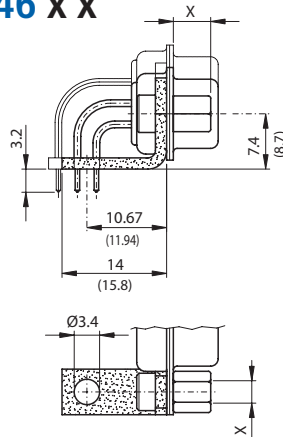

Metallwinkel / Metal bracket

| | | |
|-----------|------------------|---------|
| M46 UN B5 | Niete / back nut | UNC4-40 |
| | Schraube / screw | 5 mm |
| M46 UN B6 | Niete / back nut | UNC4-40 |
| | Schraube / screw | 6 mm |
| M46 M3 B5 | Niete / back nut | M3 |
| | Schraube / screw | 5 mm |
| M46 M3 B6 | Niete / back nut | M3 |
| | Schraube / screw | 6 mm |

M47 x

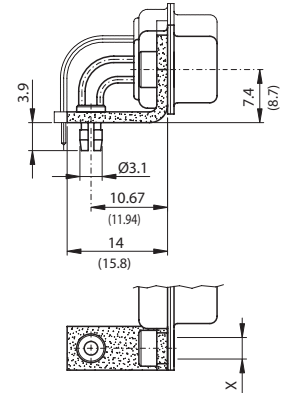

Metallwinkel mit P.o.F.
Metal bracket with P.o.F.

| | | |
|--------|------------------|----------|
| M47 D3 | Niete / rivet | Ø 3.1 mm |
| M47 UN | Niete / back nut | UNC4-40 |
| M47 M3 | Niete / back nut | M3 |

M47 x x

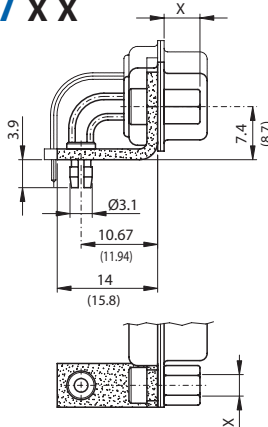

Metallwinkel mit P.o.F.
Metal bracket with P.o.F.

| | | |
|-----------|------------------|---------|
| M47 UN B5 | Niete / back nut | UNC4-40 |
| | Schraube / screw | 5 mm |
| M47 UN B6 | Niete / back nut | UNC4-40 |
| | Schraube / screw | 6 mm |
| M47 M3 B5 | Niete / back nut | M3 |
| | Schraube / screw | 5 mm |
| M47 M3 B6 | Niete / back nut | M3 |
| | Schraube / screw | 6 mm |

M48 x

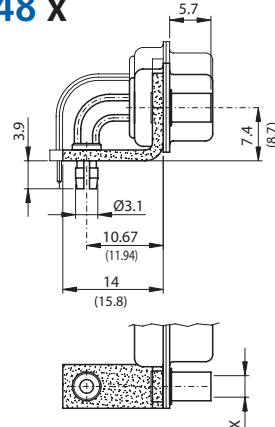

Metallwinkel mit P.o.F.
Metal bracket with P.o.F.

| | | |
|--------|-------------------|---------|
| M48 UN | Niete / front nut | UNC4-40 |
| M48 M3 | Niete / front nut | M3 |

M49 x

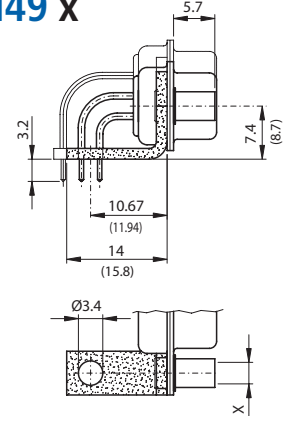

Metallwinkel / Metal bracket

| | | |
|--------|-------------------|---------|
| M49 UN | Niete / front nut | UNC4-40 |
| M49 M3 | Niete / front nut | M3 |

D-Subminiatur Steckverbinder
D-Subminiature Connectors

Montagearten; Bauhöhe 7.4 mm

Für Lötstift 90°, 9.4 mm (YC)



Assemblies; mounting height 7.4 mm

For solder pin 90°, 9.4 mm (YC)

D-Subminiatur Steckverbinder D-Subminiature Connectors

M63 x

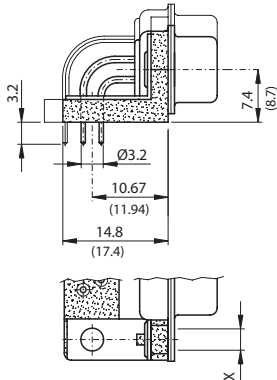

Kunststoffwinkel mit Erdungswinkel
Plastic bracket with ground strap

| | | |
|--------|------------------|----------|
| M63 D3 | Niete / rivet | Ø 3.1 mm |
| M63 UN | Niete / back nut | UNC4-40 |
| M63 M3 | Niete / back nut | M3 |

M63 x x

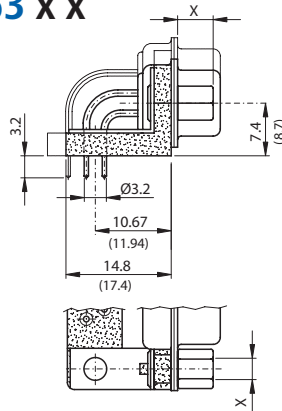

Kunststoffwinkel mit Erdungswinkel
Plastic bracket with ground strap

| | | |
|-----------|------------------|---------|
| M63 UN B5 | Niete / back nut | UNC4-40 |
| | Schraube / screw | 5 mm |
| M63 UN B6 | Niete / back nut | UNC4-40 |
| | Schraube / screw | 6 mm |
| M63 M3 B5 | Niete / back nut | M3 |
| | Schraube / screw | 5 mm |
| M63 M3 B6 | Niete / back nut | M3 |
| | Schraube / screw | 6 mm |

M64 x

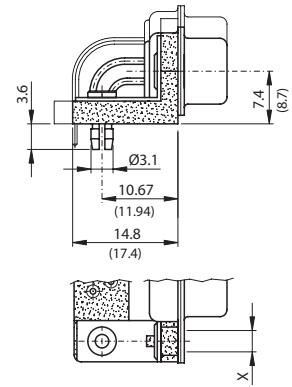

Kunststoffwinkel mit Erdungswinkel und Po.F.
Plastic bracket with ground strap and Po.F.

| | | |
|--------|------------------|----------|
| M64 D3 | Niete / rivet | Ø 3.1 mm |
| M64 UN | Niete / back nut | UNC4-40 |
| M64 M3 | Niete / back nut | M3 |

M64 x x

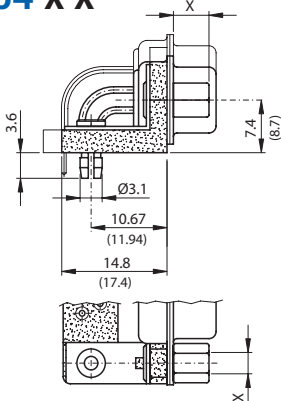

Kunststoffwinkel mit Erdungswinkel und Po.F.
Plastic bracket with ground strap and Po.F.

| | | |
|-----------|------------------|---------|
| M64 UN B5 | Niete / back nut | UNC4-40 |
| | Schraube / screw | 5 mm |
| M64 UN B6 | Niete / back nut | UNC4-40 |
| | Schraube / screw | 6 mm |
| M64 M3 B5 | Niete / back nut | M3 |
| | Schraube / screw | 5 mm |
| M64 M3 B6 | Niete / back nut | M3 |
| | Schraube / screw | 6 mm |

M61 x

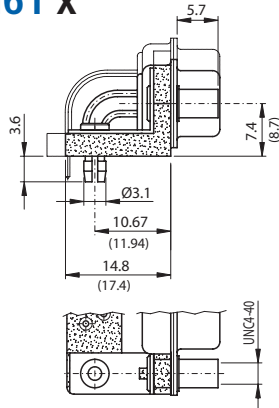

Kunststoffwinkel mit Erdungswinkel und Po.F.
Plastic bracket with ground strap and Po.F.

| | | |
|--------|-------------------|---------|
| M61 UN | Niete / front nut | UNC4-40 |
| M61 M3 | Niete / front nut | M3 |

M66 x

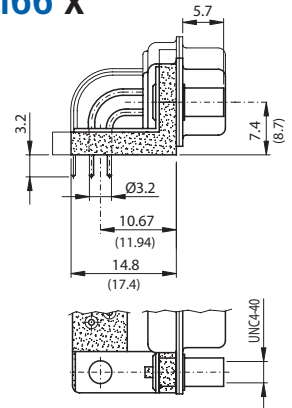

Kunststoffwinkel mit Erdungswinkel
Plastic bracket with ground strap

| | | |
|--------|-------------------|---------|
| M66 UN | Niete / front nut | UNC4-40 |
| M66 M3 | Niete / front nut | M3 |

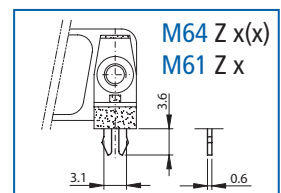

Die Montagen M64 x(x) und M61 x sind auch mit Z-Shape erhältlich.
Assemblies M64 x(x) and M61 x are available also with z-shape.



Montagearten; Bauhöhe 7.4 mm

Für Lötstift 90°, 9.4 mm (YC)

Assemblies; mounting height 7.4 mm

For solder pin 90°, 9.4 mm (YC)

M20 x x

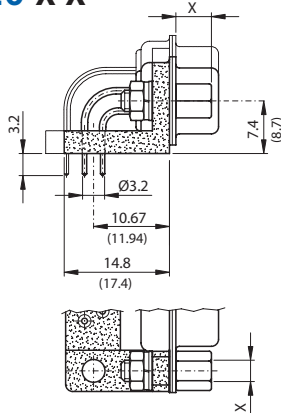

Kunststoffwinkel / Plastic bracket

| | | |
|------------------|------------------|------|
| M20 UN B5 | Schraube / screw | |
| | UNC4-40 | 5 mm |
| M20 UN B6 | Schraube / screw | |
| | UNC4-40 | 6 mm |
| M20 M3 B5 | Schraube / screw | |
| | M3 | 5 mm |
| M20 M3 B6 | Schraube / screw | |
| | M3 | 6 mm |

M70

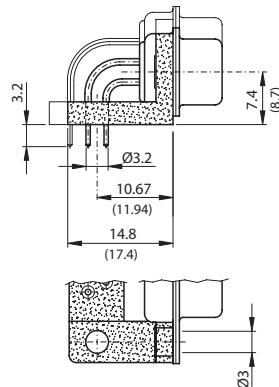

Kunststoffwinkel / Plastic bracket

| | | |
|------------|---------------|----------|
| M70 | Niete / rivet | Ø 3.1 mm |
|------------|---------------|----------|

M73 x

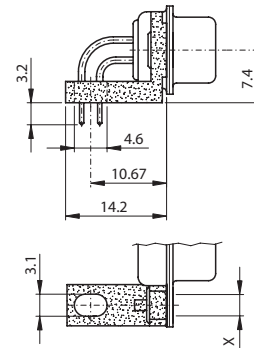

Kunststoffwinkel / Plastic bracket

| | | |
|---------------|------------------|---------|
| M73 UN | Niete / back nut | UNC4-40 |
| M73 M3 | Niete / back nut | M3 |

M73 x x

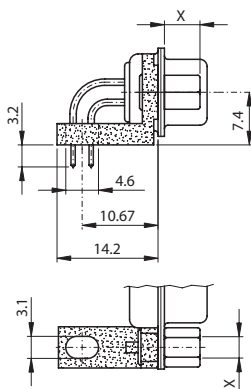

Kunststoffwinkel / Plastic bracket

| | | |
|------------------|------------------|---------|
| M73 UN B5 | Niete / back nut | UNC4-40 |
| | Schraube / screw | 5 mm |
| M73 UN B6 | Niete / back nut | UNC4-40 |
| | Schraube / screw | 6 mm |
| M73 M3 B5 | Niete / back nut | M3 |
| | Schraube / screw | 5 mm |
| M73 M3 B6 | Niete / back nut | M3 |
| | Schraube / screw | 6 mm |

M74 x

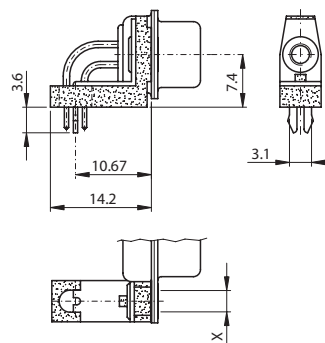

Kunststoffwinkel mit Erdungswinkel (Z)
Plastic bracket with ground strap (Z)

| | | |
|---------------|------------------|---------|
| M74 UN | Niete / back nut | UNC4-40 |
| M74 M3 | Niete / back nut | M3 |

M74 x x

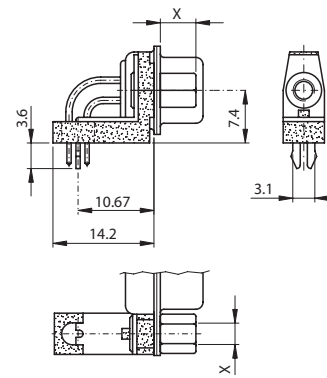

Kunststoffwinkel mit Erdungswinkel (Z)
Plastic bracket with ground strap (Z)

| | | |
|------------------|------------------|---------|
| M74 UN B5 | Niete / back nut | UNC4-40 |
| | Schraube / screw | 5 mm |
| M74 UN B6 | Niete / back nut | UNC4-40 |
| | Schraube / screw | 6 mm |
| M74 M3 B5 | Niete / back nut | M3 |
| | Schraube / screw | 5 mm |
| M74 M3 B6 | Niete / back nut | M3 |
| | Schraube / screw | 6 mm |

D-Subminiatur Steckverbinder
D-Subminiature Connectors